

UVLS-GM2-AR0822

- onsemi AR0822 8MP Rolling Shutter Sensor
- 4K HDR Imaging Capabilities
- Near Infra-Red Enhancement for Outdoor Applications
- Designed for Low Light Applications
- S-Mount for Interchangeable Lenses
- GMSL2™ (Gigabit Multimedia Serial Link) interface
- FAKRA Z-Code Automotive Connector
- Plug & Play with Linux OS & Yocto
- VizionViewer™ configuration utility
- VizionSDK for custom development

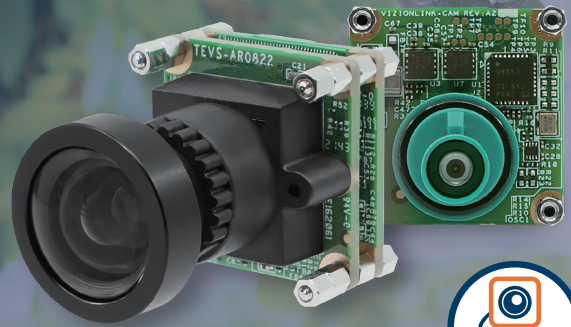

VizionSDK VizionViewer™

Camera Information

CMOS Sensor	onsemi AR0822
Active Pixels	3840 (H) x 2160 (V) = 8 MP
Pixel Size	2.0 μm x 2.0 μm
Illuminated Type	Back Side Illuminated (BSI)
Maximum S/N Ratio	40.5 dB
Optical Format	1/2" (Diagonal 8.81 mm)
Shutter Type	Rolling Shutter
Chromaticity	Color / Mono
HDR Support	Yes
Maximum Frame Rate (YUV422-UYYV)	3840 x 2160 @ 15 fps 2560 x 1440 @ 30 fps 1920 x 1080 @ 60 fps 1280 x 720 @ 60 fps 640 x 480 @ 60 fps
Output Format	YUV422-UYYV RGB888 / RGB565 RAW8 / RAW10 / RAW12

Camera Interface

Serial Link	GMSL2
Serializer	MAX96717
Connector	FAKRA SMB Jack Z-Code

Power

Power over Coax	10.8V - 26.4V
Power Consumption	3840 x 2160 @ 15 fps ≤ 1.56W
Standby Power	≤ 0.6W Standby

Software Support

Platform Support	NVIDIA Jetson AGX Orin NVIDIA Jetson Orin Nano / NX NXP i.MX95 NXP i.MX8M Plus Intel Arrow Lake Intel Panther Lake
Operation System	Linux Yocto
Software	VizionViewer™
Development SDK	VizionSDK

Environmental and Mechanical

Dimensions	24.5(W) x 24.5(H) x 34.4(D) mm
Weight	≤ 25 grams
Operating Temperature	-30°C to + 70°C

Certification and Compliance

Certification	Compliant with CE / FCC / RoHS / REACH directives
---------------	---

Spectral Characteristics

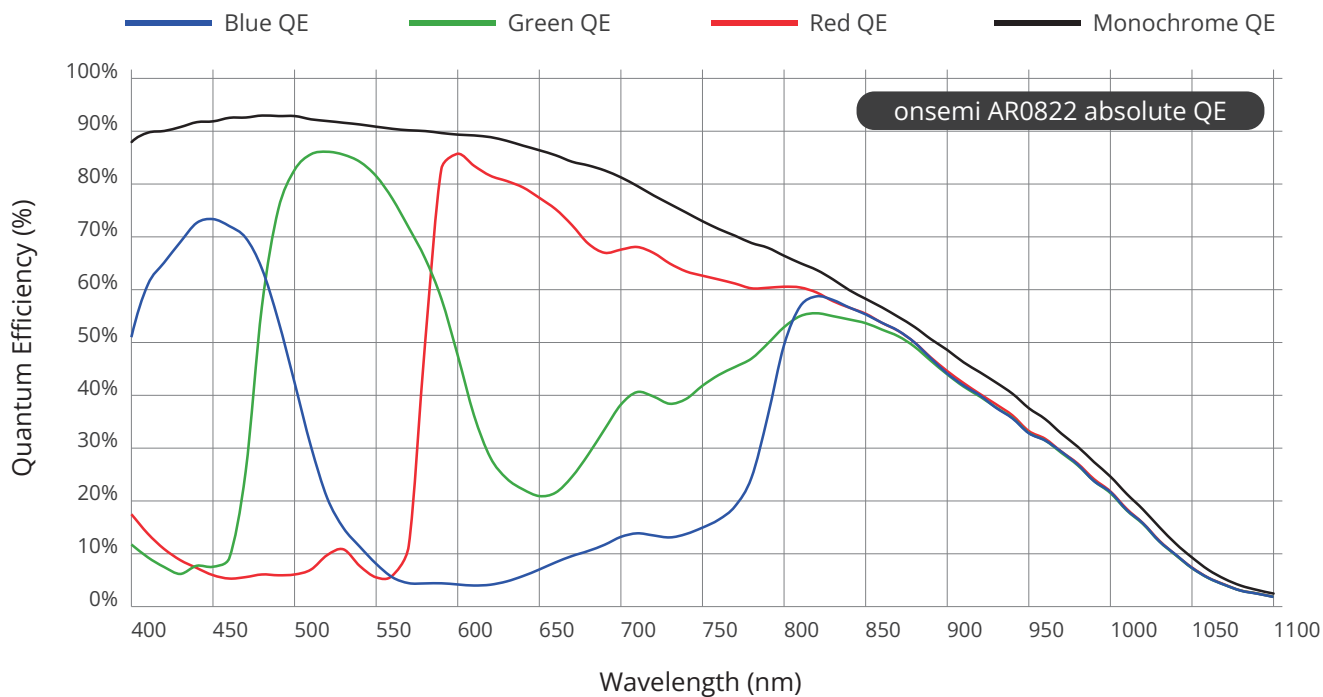

Block Diagram

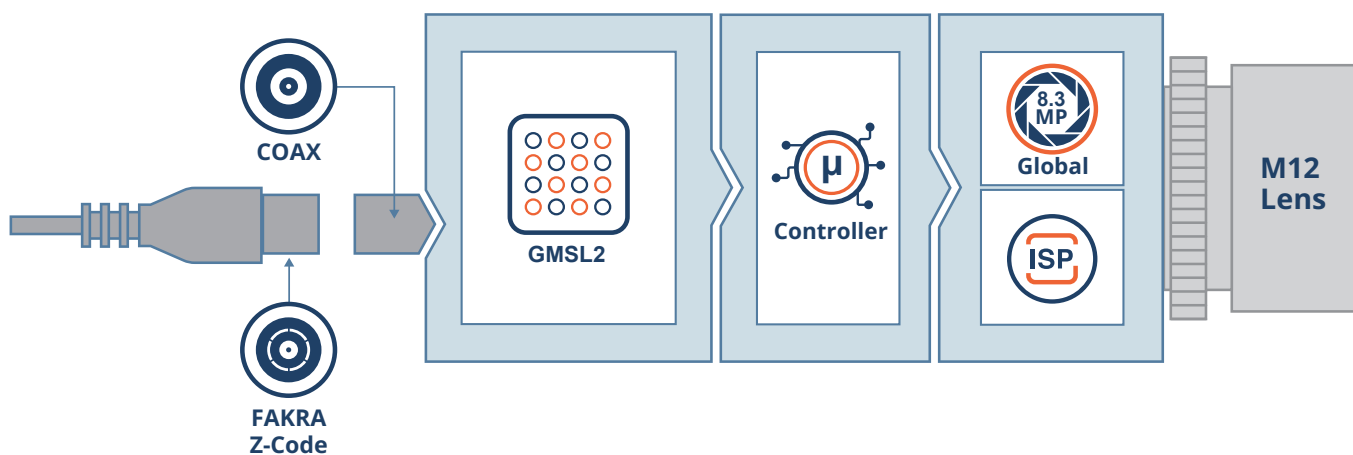

Dimensions (units in mm)

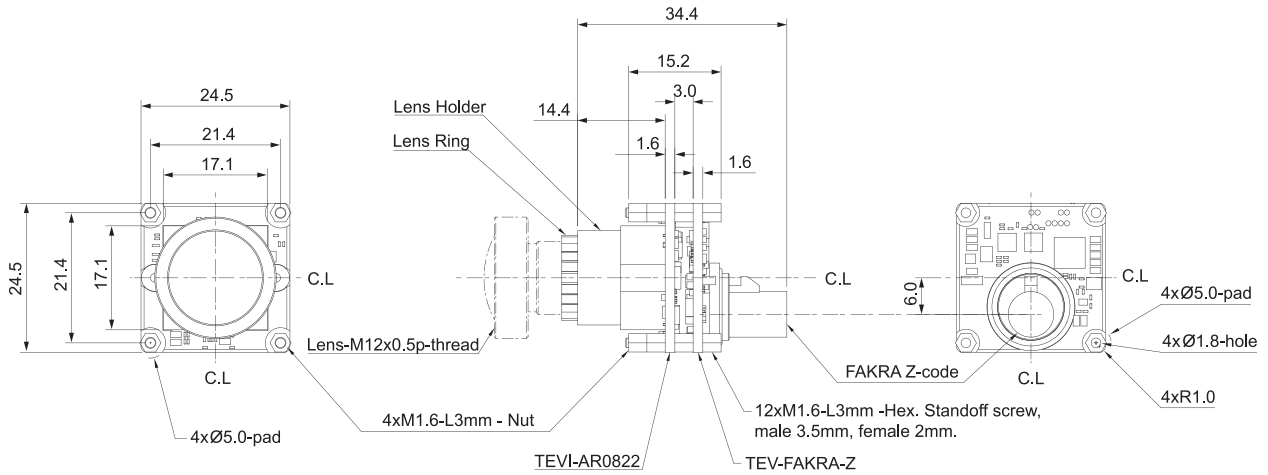

Order Information

UVLS-GM2-AR0822-x-Sxx-xx-xxxx

Option	Code	Description
Chromaticity	C	Color
	M	Monochrome
Lens	S42	S-Mount Module D-FOV 42°
	S72	S-Mount Module D-FOV 72°
	S108	S-Mount Module D-FOV 108°
	S150	S-Mount Module D-FOV 150°
Filter	-	-
	IR	IR Cut Filter 650nm
Custom ID	xxxx	Custom Part number ID

For customization, please contact your TechNexion sales representative.

Optional Accessories

An easy to attach A-Mount bracket for TechNexion 30mm enclosed cameras.



245-MOUNT-BRACKET









245-MOUNT-BRACKET on tripod
(tripod not included)

Custom Lens Solutions

				
	UVLS-GM2-AR0822-C-S42-IR	UVLS-GM2-AR0822-C-S72-IR	UVLS-GM2-AR0822-C-S108-IR	UVLS-GM2-AR0822-C-S150-IR
Focus Type	Fixed Focus	Fixed Focus	Fixed Focus	Fixed Focus
Focal Length	12 mm	6 mm	3 mm	3.2 mm
Aperture	F2.0	F2.8	F2.0	F2.0
Module D-FOV	41.7° ± 5%	72.0° ± 5%	108.6° ± 5%	150.0° ± 5%
Module H-FOV	36.3° ± 5%	64.7° ± 5%	104.0° ± 5%	132.6° ± 5%
Module V-FOV	20.5° ± 5%	39.0° ± 5%	72.2° ± 5%	77.6° ± 5%
TTL	23.09 mm	28.6 mm	29.56 mm	44.98 mm
BFL	5.06 mm	8.8 mm	4.85 mm	6.14 mm
MOD	0.15 m	0.1 m	0.3 m	0.3 m
Distortion	<2%	<0.50%	<-5%	<-32%
IR-Filter	650 nm	650 nm	650 nm	650 nm
Lens Structure	5G + IR	7G + IR	2G + 3P + IR	8G + IR
First layer material	Glass	-	Glass	Glass

GMSL2 Frame Grabbers

The ease of usage, benefits and integration of a GMSL camera in embedded systems is often made complex by the lack of GMSL ports and connectors on the system. For those scenarios TechNexion developed a range of framegrabbers that easily plug into a USB port and extend the system with 1 to 4 GMSL interconnects.

	<p>1-4 Port Connect up-to 4 GMSL cameras to a single USB port on your x86 or Arm based system.</p>		<p>Software Linux and Windows systems are supported.</p>
	<p>UVC Compliant Fully plug-n-play in Windows and Linux embedded systems.</p>		<p>VizionViewer™ Easy to use software utility providing you with granular camera settings control.</p>
	<p>Autodetect Zero configuration required to detect any specific TechNexion GMSL camera by the framegrabber.</p>		<p>VizionSDK Hardcode and control your cameras with C++ and Python code.</p>

