

TEVS-AR1335

TechNexion
INNOVATORS OF TECHNOLOGY

- onsemi AR1335 13MP rolling shutter camera sensor with ISP
- Designed for low light and high dynamic range performance
- Convenient S-Mount (M12) interchangeable lens
- VizionViewer™ configuration utility
- VizionSDK for custom development

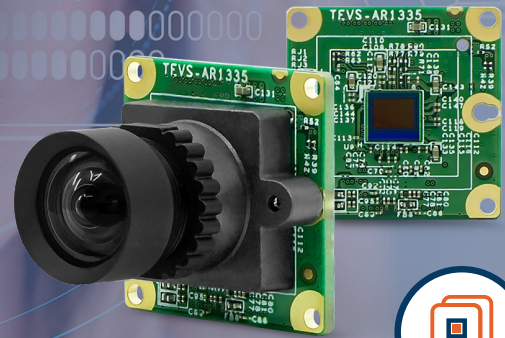

VizionSDK

VizionViewer™

Camera Information

CMOS Sensor	onsemi AR1335
Active Pixels	4208 (H) x 3120 (V) = 13 MP
Pixel Size	1.1 μm x 1.1 μm
Illuminated Type	Back Side Illuminated (BSI)
Maximum S/N Ratio	37 dB
Input Clock Range	48 MHz
Optical Format	1/3.2" (Diagonal 5.8 mm)
Shutter Type	Rolling Shutter
Chromaticity	Color
Maximum Frame Rate (YUV422-UYYV)	4208 x 3120 @ 10 fps 3840 x 2160 @ 15 fps 2560 x 1440 @ 30 fps 1920 x 1080 @ 60 fps 1280 x 720 @ 120 fps 640 x 480 @ 60 fps
Output Format	YUV422-UYYV / YUV420 RGB888 / RGB565 / RGB555 JPEG / MJPEG RAW8 / RAW10 / RAW12

Camera Interface

Module Data Transmission	MIPI CSI-2, up to 4 lanes
Communication Interface	I ² C
Connector	70 Pin Standardized Connector

Environmental and Mechanical

Dimensions	24.5(W) x 24.5(H) x 3.495(D) mm
Weight	≤ 3 grams
Operating Temperature	-30°C to + 70°C

Software Support

Platform Support	NXP NVIDIA Texas Instruments Intel Renesas Synaptics STMicroelectronics BeagleBoard Raspberry Pi
Operation System	Linux Yocto Android
Software	VizionViewer™
Development SDK	VizionSDK

Power

Supply Voltage	I/O: 1.8V Analog: 2.8V Digital: 1.15V & 3.3V
Power Consumption	4300 x 3120 @ 10 fps ≤ 723 mW
SW Standby Power	≤ 58 mW Standby
HW Standby Power	≤ 26 mW Standby

Certification and Compliance

Certification	Compliant with CE / FCC / RoHS / REACH directives
---------------	---

Spectral Characteristics

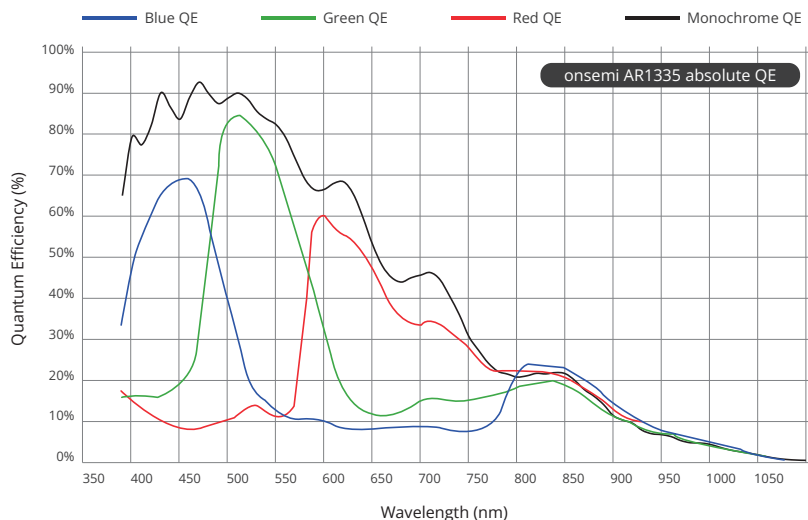

Block Diagram

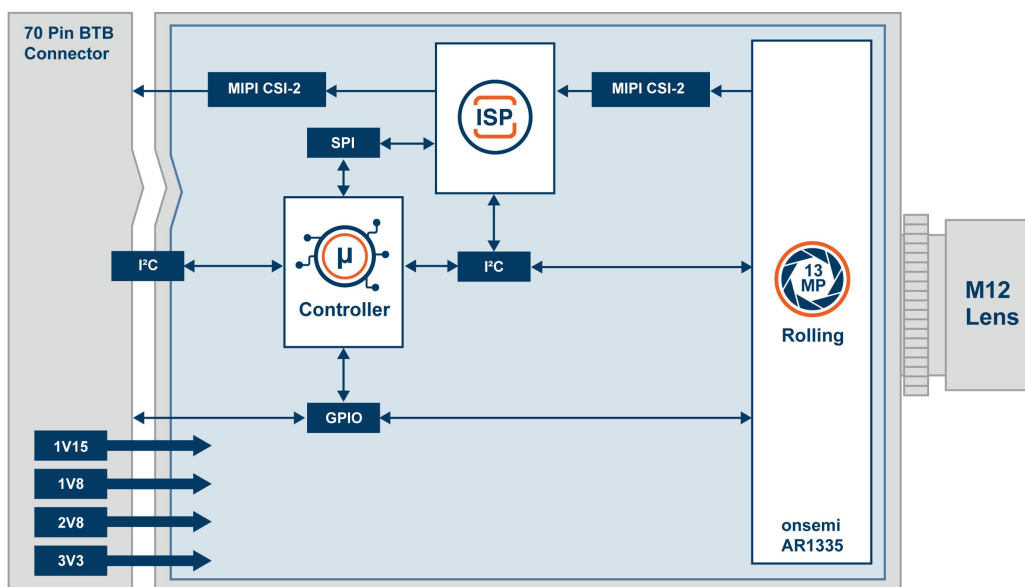

Dimensions (units in mm)

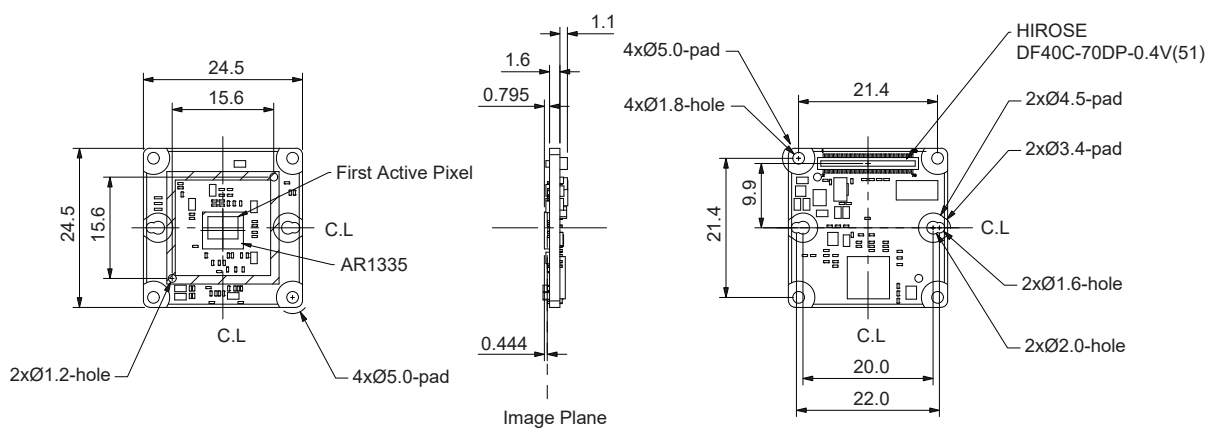

70 Pin Connector Pin Definition

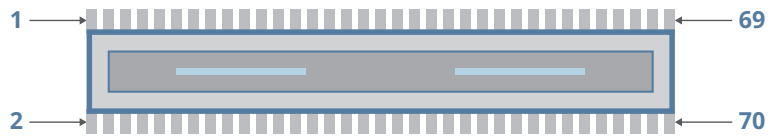
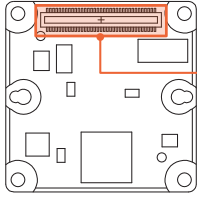

DF40C-70DP-0.4V(51)

No.	Pin Define	Level	No.	Pin Define	Level
01	3V3D	3.3V	02	3V3D	3.3V
03	3V3D	3.3V	04	3V3D	3.3V
05	GND	GND	06	GND	GND
07	NC		08	NC	
09	GND	GND	10	GND	GND
11	2V8A	2.8V	12	2V8A	2.8V
13	GND	GND	14	GND	GND
15	1V8D	1.8V	16	1V8D	1.8V
17	GND	GND	18	GND	GND
19	1V15D	1.15V	20	1V15D	1.15V
21	GND	GND	22	GND	GND
23	NC		24	NC	
25	NC		26	NC	
27	NC		28	NC	
29	NC		30	NC	
31	NC		32	NC	
33	MCU_INT_1V8_N	1.8V	34	NC	
35	GND	GND	36	GND	GND
37	H_CAM_DN0		38	CSI_FRAME_SYNC	1.8V
39	H_CAM_DP0		40	CSI_nRST	1.8V
41	GND	GND	42	GND	GND
43	H_CAM_DN1		44	NC	1.8V
45	H_CAM_DP1		46	CSI_FLASH_OUT	1.8V
47	GND	GND	48	GND	GND
49	H_CAM_DN2		50	STANDBY	1.8V
51	H_CAM_DP2		52	CSI_SHUTTER	1.8V
53	GND	GND	54	GND	GND
55	H_CAM_DN3		56	H_I2C_SCL	1.8V
57	H_CAM_DP3		58	H_I2C_SDA	1.8V
59	GND	GND	60	GND	GND
61	H_CAM_CKN		62	NC	
63	H_CAM_CKP		64	NC	
65	GND	GND	66	NC	
67	NC		68	NC	
69	GND	GND	70	GND	GND

15 Pin Connector Pin Definition



No.	Pin Define	Description
01	3V3	Power 3V3
02	I2C_SDA	Two-Wire Serial Data 3V3
03	I2C_SCL	Two-Wire Serial Clock 3V3
04	Reserved	Reserved
05	CSI_RST	Camera Reset Input 3V3
06	GND	Ground
07	CSI_CAM_CKP	MIPI Clock Lane Positive
08	CSI_CAM_CKN	MIPI Clock Lane Negative
09	GND	Ground
10	CSI_CAM_DP1	MIPI Data Lane 1 Positive
11	CSI_CAM_DN1	MIPI Data Lane 1 Negative
12	GND	Ground
13	CSI_CAM_DP0	MIPI Data Lane 0 Positive
14	CSI_CAM_DN0	MIPI Data Lane 0 Negative
15	GND	Ground

Camera Expansion Header

No.	Name	Voltage	Description
01	3V3	3V3	Power Output
02	FRAME_SYNC	3V3	Frame Sync input
03	EXPOSURE	3V3	Exposure input
04	FLASH	3V3	Flash output
05	SHUTTER	3V3	Shutter output
06	GND	Ground	GND

22 Pin Connector Pin Definition

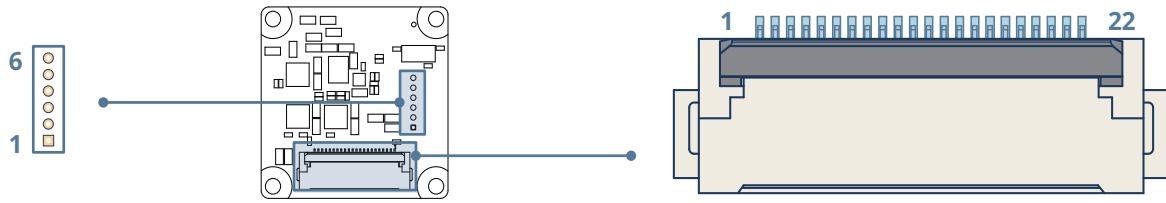

No.	Pin Define	Description
01	3V3	Power 3V3
02	I2C_SDA	Two-Wire Serial Data 3V3
03	I2C_SCL	Two-Wire Serial Clock 3V3
04	GND	Ground
05	Reserved	Reserved
06	CDI_RST	Camera reset Input 3V3
07	GND	Ground
08	CSI_CAM_DP3	MIPI Data Lane 3 Positive
09	CSI_CAM_DN3	MIPI Data Lane 3 Negative
10	GND	Ground
11	CSI_CAM_DP2	MIPI Data Lane 2 Positive
12	CSI_CAM_DN2	MIPI Data Lane 2 Negative
13	GND	Ground
14	CSI_CAM_CKP	MIPI Clock Lane Positive
15	CSI_CAM_CKN	MIPI Clock Lane Negative
16	GND	Ground
17	CSI_CAM_DP1	MIPI Data Lane 1 Positive
18	CSI_CAM_DN1	MIPI Data Lane 1 Negative
19	GND	Ground
20	CSI_CAM_DP0	MIPI Data Lane 0 Positive
21	CSI_CAM_DN0	MIPI Data Lane 0 Negative
22	GND	Ground

Camera Expansion Header

No.	Name	Voltage	Description
01	3V3	3V3	Power Output
02	FRAME_SYNC	3V3	Frame Sync input
03	EXPOSURE	3V3	Exposure input
04	FLASH	3V3	Flash output
05	SHUTTER	3V3	Shutter output
06	GND	Ground	GND

Lens Information

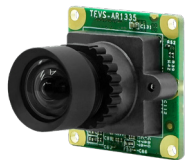

TEVS-AR1335-C-S85-IR

Focus Type	Fixed Focus
Focal Length	3.2 mm
Aperture	F2.4
Module D-FOV	84.6° ± 5%
Module H-FOV	70.3° ± 5%
Module V-FOV	55.2° ± 5%
TTL	22 mm
BFL	3.4 mm
MOD	0.3 m
Distortion	<1.6%
IR-Filter	650 nm
Lens Structure	4G + 2P+ IR
First layer material	Glass

Order Information

TEVS-AR1335-x-Sxx-xx-xxx-xxxx

Option	Code	Description
Chromaticity	C	Color
Lens	S85	S-Mount Module D-FOV 85°
Filter	-	-
	IR	IR Cut Filter 650nm
Evaluation Kit	-	70 pin Standardized Camera Connector
	EVK	70 pin Standardized Camera Connector with FPC cable
	RPI15	15 pin Standardized ZIF Connector with FFC cable
	RPI22	22 pin Standardized ZIF Connector with FFC cable
	NXP	Mini-SAS connection cable for NXP Evaluation Board
Custom ID	xxxx	Custom Part number ID

For customization, please contact your TechNexion sales representative.

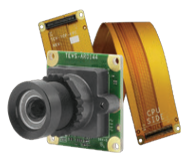

TechNexion EVK

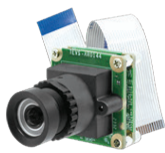

RPI15

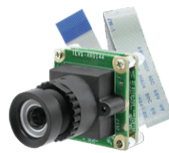



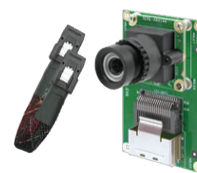





RPI22



Mini-SAS

Cross-Platform Support

TechNexion's camera modules are designed for seamless integration across all platforms, enabling faster innovation and quicker time-to-market. Experience high-performance cameras that adapt to your needs and maximize your system's potential.

	i.MX95 i.MX93 i.MX8M Plus i.MX8M Mini		Jetson AGX Thor Jetson AGX Orin Jetson Orin NX Jetson Orin Nano Jetson Xavier NX Jetson Nano
	Alder Lake-N Meteor Lake Arrow Lake Panther Lake		Sitara AM62 / AM62A Sitara AM67 / 68 / 69 Jacinto TDA4VM Jacinto TDA4VH
	RZ/V2N RZ/V2H		BeagleY-AI BeaglePlay
	Raspberry Pi 4 Raspberry Pi 5		SL2610 SL1680 SL1640 SL1620
	STM32 MP25 STM32 N6		

Software Support

Compatible with VizionSDK — a cross-platform C++, Python SDK for Windows and Linux. Enables full control of TechNexion cameras across multiple environments, including Ubuntu, Windows 10/11, NXP i.MX, and NVIDIA Jetson.



VizionSDK



VizionViewer™





Find all Software on

<https://www.technexion.com>

Software SDK Available

TechNexion
 INNOVATORS OF TECHNOLOGY

For more information:
 www.technexion.com
 sales@technexion.com