

TEVS-AR0522

- Onsemi AR0522 5MP rolling shutter camera sensor with ISP.
- Designed for low light and high dynamic range performance.
- Convenient S-Mount (M12) interchangeable lens.
- VizionViewer™ configuration utility
- VizionSDK for custom development

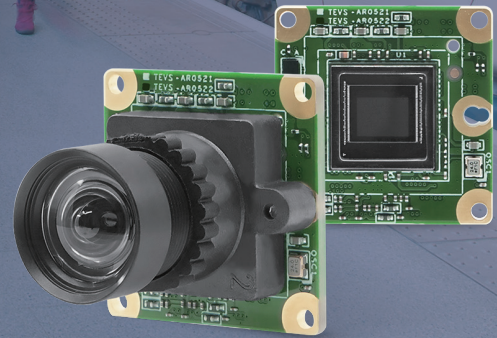

VizionSDK



VizionViewer™

Camera Information

CMOS Sensor	onsemi AR0522
Active Pixels	2592 (H) x 1944 (V) = 5 MP
Pixel Size	2.2 μm x 2.2 μm
Illuminated Type	Back Side Illuminated (BSI)
Maximum S/N Ratio	40 dB
Input Clock Range	48 MHz
Optical Format	1/2.5" (Diagonal 7.13 mm)
Shutter Type	Rolling Shutter
Chromaticity	Color / Mono
Maximum Frame Rate (YUV422-UYYVY)	2592 x 1944 @ 24 fps 2560 x 1440 @ 32 fps 1920 x 1080 @ 60 fps 1280 x 960 @ 60 fps 1280 x 720 @ 60 fps 640 x 480 @ 120 fps
Output Format	YUV422-UYYVY / YUV420 RGB888 / RGB565 / RGB555 JPEG / MJPEG RAW8 / RAW10 / RAW12

Camera Interface

Module Data Transmission	MIPI CSI-2, up to 4 lanes
Communication Interface	I ² C
Connector	70 Pin Standardized Connector

Environmental and Mechanical

Dimensions	24.5(W) x 24.5(H) x 4.36(D) mm
Weight	≤ 3 grams
Operating Temperature	-30°C to + 70°C

Software Support

Platform Support	NVIDIA Jetson AGX Orin NVIDIA Jetson Orin Nano / NX NVIDIA Jetson Xavier NX NVIDIA Jetson Nano NXP i.MX8M Nano / Mini / Plus NXP i.MX93 / i.MX95 TI Sitara™ AM62 / AM62A TI Sitara™ AM67 / AM68 / AM69 TI Jacinto™ TDA4VM / TDA4VH BeagleY®-AI / BeaglePlay® Raspberry Pi 4 / Raspberry Pi 5 ST STM32MP25 Renesas RZ/V2N / RZ/V2H Intel x86
Operation System	Linux Android
Software	VizionViewer™
Development SDK	VizionSDK

Power

Supply Voltage	I/O: 1.8V Analog: 2.8V Digital: 1.15V & 3.3V
Power Consumption	2592 x 1944 @ 24 fps ≤ 678 mW
SW Standby Power	≤ 43 mW Standby
HW Standby Power	≤ 20 mW Standby

Certification and Compliance

Certification	Compliant with CE / FCC / RoHS / REACH directives
---------------	---

Spectral Characteristics

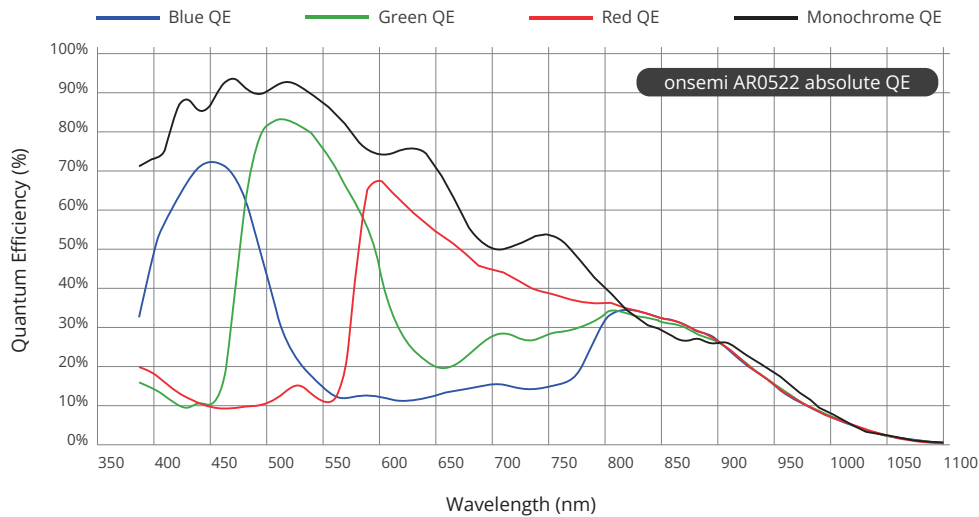

Block Diagram

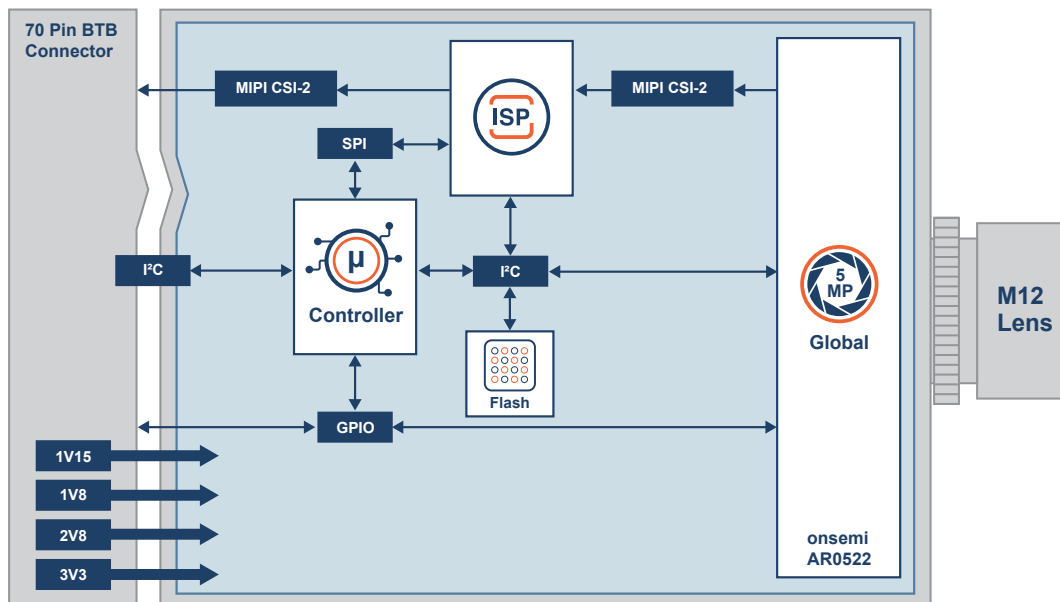

Dimensions (units in mm)

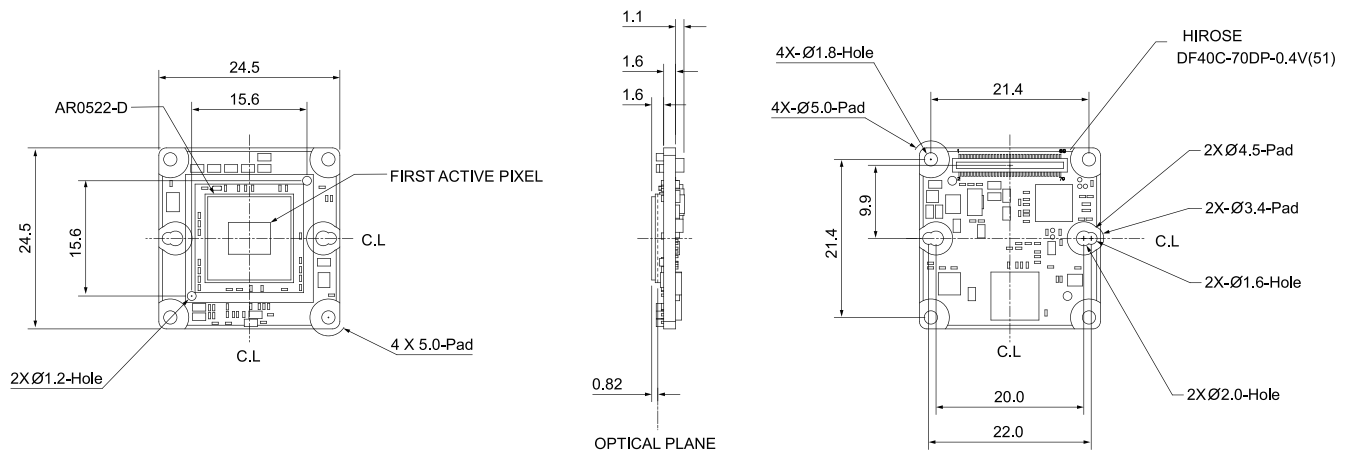

Connector Pin Definition

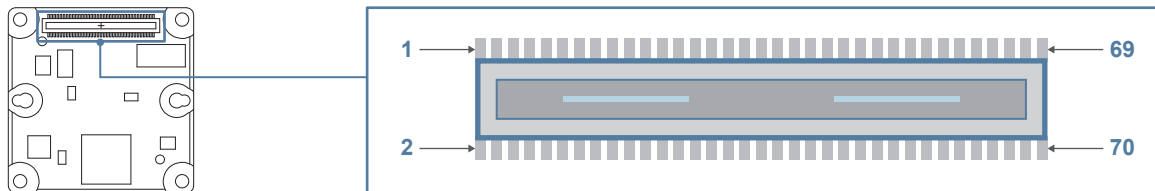

DF40C-70DP-0.4V(51)

No.	Pin Define	Level	No.	Pin Define	Level
01	3V3D	3.3V	02	3V3D	3.3V
03	3V3D	3.3V	04	3V3D	3.3V
05	GND	GND	06	GND	GND
07	NC		08	NC	
09	GND	GND	10	GND	GND
11	2V8A	2.8V	12	2V8A	2.8V
13	GND	GND	14	GND	GND
15	1V8D	1.8V	16	1V8D	1.8V
17	GND	GND	18	GND	GND
19	1V15D	1.15V	20	1V15D	1.15V
21	GND	GND	22	GND	GND
23	NC		24	NC	
25	NC		26	NC	
27	NC		28	NC	
29	NC		30	NC	
31	NC		32	NC	
33	MCU_INT_1V8_N	1.8V	34	NC	
35	GND	GND	36	GND	GND
37	H_CAM_DN0		38	CSI_FRAME_SYNC	1.8V
39	H_CAM_DP0		40	CSI_nRST	1.8V
41	GND	GND	42	GND	GND
43	H_CAM_DN1		44	NC	1.8V
45	H_CAM_DP1		46	CSI_FLASH_OUT	1.8V
47	GND	GND	48	GND	GND
49	H_CAM_DN2		50	STANDBY	1.8V
51	H_CAM_DP2		52	CSI_SHUTTER	1.8V
53	GND	GND	54	GND	GND
55	H_CAM_DN3		56	H_I2C_SCL	1.8V
57	H_CAM_DP3		58	H_I2C_SDA	1.8V
59	GND	GND	60	GND	GND
61	H_CAM_CKN		62	NC	
63	H_CAM_CKP		64	NC	
65	GND	GND	66	NC	
67	NC		68	NC	
69	GND	GND	70	GND	GND

Lens Information

	 TEVS-AR0522-C-S34-IR	 TEVS-AR0522-C-S85-IR	 TEVS-AR0522-C-S140-IR
Focus Type	Fixed Focus	Fixed Focus	Fixed Focus
Focal Length	12 mm	3.9 mm	2.87 mm
Aperture	F2.0	F2.8	F2.8
Module D-FOV	33.6° ± 5%	85.2° ± 5%	140.0° ± 5%
Module H-FOV	26.8° ± 5%	73.0° ± 5%	110.5° ± 5%
Module V-FOV	20.1° ± 5%	58.1° ± 5%	81.4° ± 5%
TTL	23.2 mm	22 mm	21 mm
BFL	7.3 mm	4.54 mm	5.27 mm
MOD	0.3 m	0.3 m	0.3 m
Distortion	<-2.50%	<1.26%	<-20%
IR-Filter	650 nm	650 nm	650 nm

Order Information

TEVS-AR0522-x-Sxx-xx-xxx-xxxx

Option	Code	Description
Chromaticity	C	Color
	M	Monochrome
Lens	S34	S-Mount Module D-FOV 34°
	S85	S-Mount Module D-FOV 85°
	S140	S-Mount Module D-FOV 140°
Filter	-	-
	IR	IR Cut Filter 650nm
Evaluation Kit	-	70 pin Standardized Camera Connector
	EVK	70 pin Standardized Camera Connector with FPC cable
	RPI15	15 pin Standardized ZIF Connector with FFC cable
	RPI22	22 pin Standardized ZIF Connector with FFC cable
	NXP	Mini-SAS connection cable for NXP Evaluation Board
Custom ID	xxxx	Custom Part number ID for customized Software loader and special component (BOM)

For customization, please contact your TechNexion sales representative.

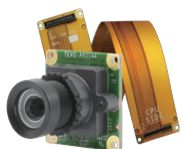

TechNexion EVK

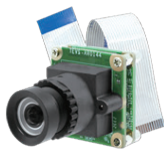

RPI15



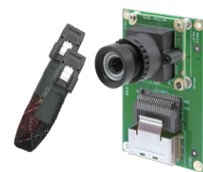

RPI22



Mini-SAS

Cross-Platform Support

TechNexion's camera modules are designed for seamless integration across all platforms, enabling faster innovation and quicker time-to-market. Experience high-performance cameras that adapt to your needs and maximize your system's potential.

	i.MX95 i.MX93 i.MX8M Plus i.MX8M Nano / Mini		Jetson AGX Orin Jetson Orin NX Jetson Orin Nano Jetson Xavier NX Jetson Nano
	RZ/V2N RZ/V2H		Sitara AM62 / AM62A Sitara AM67 Sitara AM68 / AM69 Jacinto TDA4VM Jacinto TDA4VH
	Alder Lake-N Meteor Lake		BeagleY-AI BeaglePlay
 Raspberry Pi	Raspberry Pi 4 Raspberry Pi 5		STM32 MP25



VizionSDK



VizionViewer™



Software SDK Available



Find all Software on

<https://www.technexion.com>

TechNexion
INNOVATORS OF TECHNOLOGY

For more information:
 www.technexion.com
 sales@technexion.com